

Numark[®]

Professional Disc Jockey Products

DM1295

PROFESSIONAL DJ SAMPLING MIXER

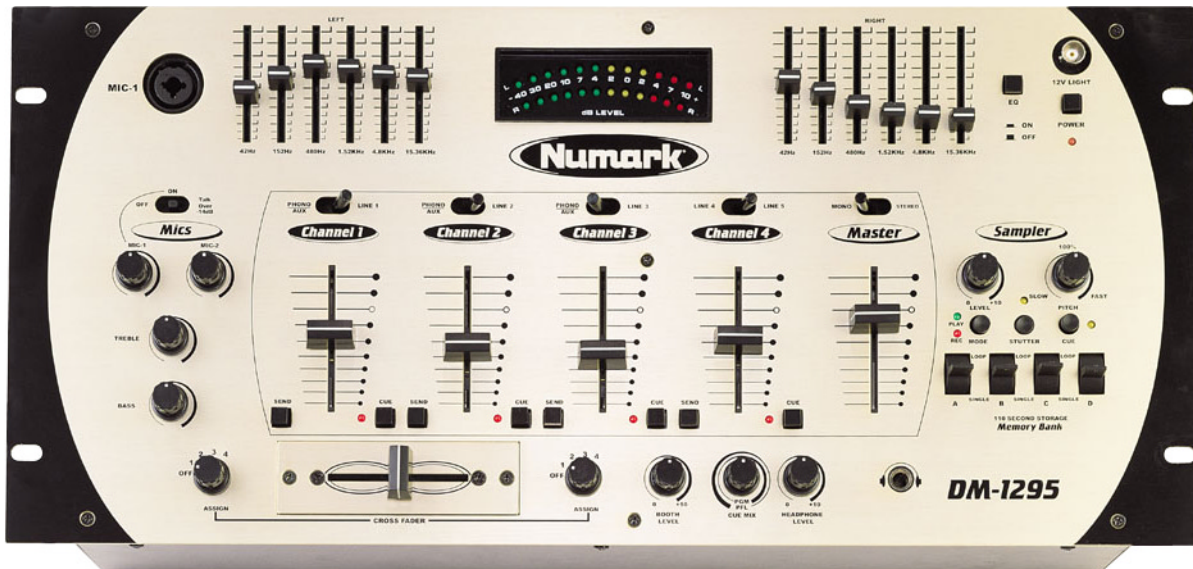

Owner's Manual

Safety Information



CAUTION: TO REDUCE THE RISK OF ELECTRIC SHOCK DO NOT REMOVE ANY COVER. NO USER-SERVICEABLE PARTS INSIDE. REFER SERVICING TO QUALIFIED SERVICE PERSONNEL ONLY.

The lightning flash with arrowhead symbol within the equilateral triangle is intended to alert the user to the presence of un-insulated "dangerous voltage" within the product's enclosure that may be of sufficient magnitude to constitute a risk of electric shock.

The exclamation point within the equilateral triangle is intended to alert the user to the presence of important operating and maintenance (servicing) instructions in the literature accompanying this appliance.

CAUTION
 FOR USA & CANADIAN MODELS ONLY
 TO PREVENT ELECTRIC SHOCK DO NOT USE THIS (POLARIZED) PLUG WITH AN EXTENSION CORD, RECEPTACLE OR OTHER OUTLET UNLESS THE BLADES CAN BE FULLY INSERTED TO PREVENT BLADE EXPOSURE.

SAFETY INSTRUCTIONS

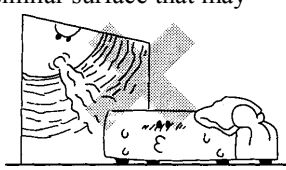
- a) Read Instructions - All the safety and operating instructions should be read before this product is connected and used.
- b) Retain Instructions - The safety and operating instructions should be kept for future reference.
- c) Heed Warnings - All warnings on this product and in these operating instructions should be followed.
- d) Follow Instructions - All operating and other instructions should be followed.
- e) Water and Moisture - This product should be kept away from direct contact with liquids. 
- f) Heat - Avoid placing this product too close to any high heat sources such as radiators.
- g) Ventilation - The appliance should be situated so that its location or position does not interfere with its proper ventilation. For example, the appliance should not be situated on a bed, sofa, rug, or similar surface that may block the ventilation opening; or, placed in a built-installation, such as bookcase or cabinet that may impede the flow of air through the ventilation openings. 

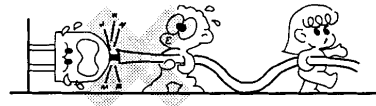
- h) Power Sources - This product should be connected to a power supply only of the type described in these operating instructions, or as marked on the unit.
- i) Power Cord Protection - Power supply cords should be routed so that they are not likely to be walked upon or pinched by items placed on or against them. When removing the cord from a power outlet be sure to remove it by holding the plug attachment and not by pulling on the cord. 

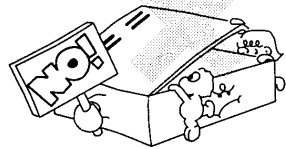
- j) Object and Liquid Entry - Take care that objects do not fall into and that liquids are not spilled into the inside of the mixer.
- k) Cleaning - The appliance should be cleaned only as recommended by the manufacturer.
- l) Non-use Periods - The power cord of the appliance should be unplugged from the outlet when left unused for long periods of time.
- m) Damage Requiring Service - Never attempt to make any adjustments or repairs other than those described in this manual. Only qualified personnel should service this product. If you have any questions about service please contact Numark at the number(s) shown on the back cover of this manual. 

- n) Grounding or Polarization - Precautions should be taken so that the grounding or polarization means built into the CD player is not defeated.
- o) Internal/External Voltage Selectors - Internal or external voltage selector switches, if any, should only be reset and re-equipped with a proper plug for alternative voltage by a qualified service technician. Do not attempt to alter this yourself.

WARNING: To reduce the risk of fire or electrical shock, do not expose this appliance to rain or moisture. Electrical equipment should NEVER be kept or stored in damp environments.

SERVICE INSTRUCTIONS

- Disconnect power cord before servicing
- Replace critical components  only with factory parts or recommended equivalents
- For AC line powered units - Before returning repaired unit to user, use an ohmmeter to measure from both AC plug blades to all exposed metallic parts. The resistance should be no more than 100,000ohms.

Numark® DM1295 PROFESSIONAL DJ MIXER

with onboard sampler

CONGRATULATIONS!

You have purchased the **DM1295** stereo preamp mixer with onboard sampler. Numark's engineers have designed this mixer to accommodate both the mobile DJ market and the professional installation market. The **DM1295** provides the end user with high-end audio circuitry combined with maximum versatility to meet the demands of every intended situation. This mixer features 8 line, 3 phono, and 2 microphone inputs, balanced XLR outputs, and a built in sampler with 110 seconds of memory storage and polyphonic playback.

Thank you for purchasing NUMARK products!

Mixer Features:

- 8 Line, 3 phono, 2 mic inputs
- Completely assignable and replaceable cross-fader
- Dual 6-band graphic equalizer with on/off switch
- Master and zone level controls
- Mic inputs have EQ and talk-over control
- Front panel mic with Neutrik™ connectors (XLR or 1/4")
- Booth output
- Individual channel sends
- Split cue headphone monitoring
- Master balanced XLR outputs
- 12V BNC light connector

SAMPLER Features:

- 110 seconds of memory storage
- Retainable memory
- Polyphonic playback
- Pitch adjustment of +35% to -100%
- Looping and single play capability with stuttering

Table of Contents

Safety Measures	2		
Introduction	3	Specifications	10
Registration	3	Block Diagram	11
Description of the Features	4	Warranty	12
Quick Setup Diagram	7		

Product Registration

Please record the serial number of your unit as shown on the back of the chassis as well as the name of the dealer from whom you purchased the unit. Retain this information and your original purchase receipt for your records. Please return the enclosed warranty card to register your unit with us.

MODEL: _____
SERIAL NUMBER: _____

PURCHASED FROM: _____
DATE OF PURCHASE: _____

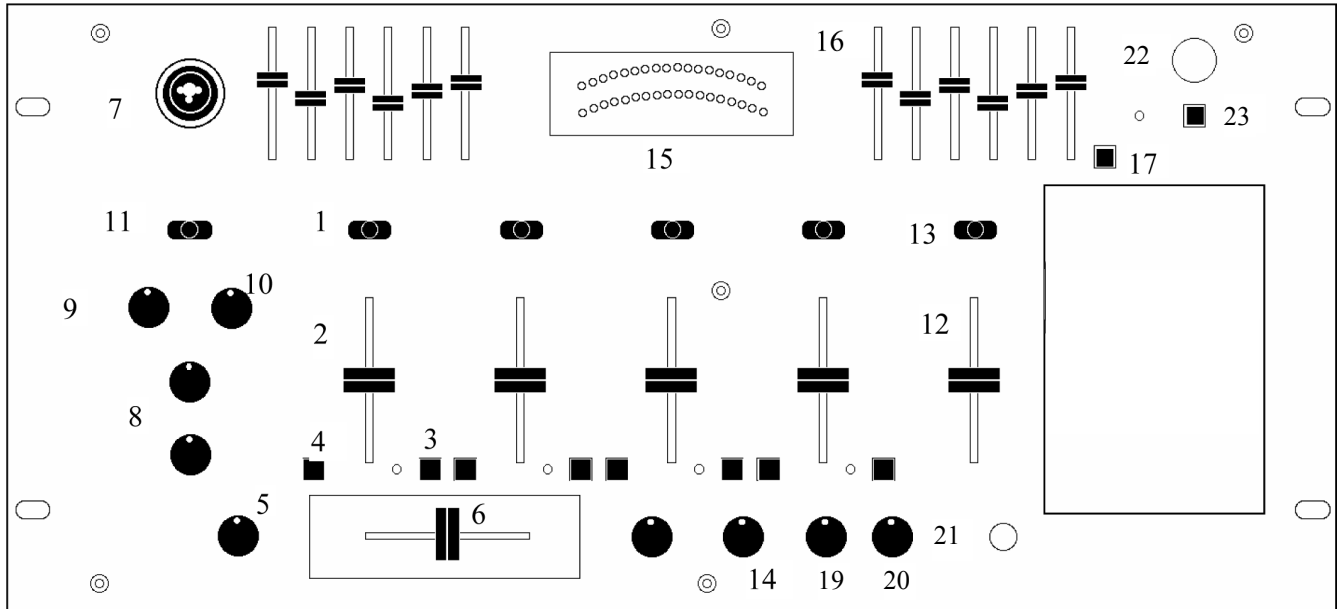
MIXER FEATURES**INPUTS**

- Input Toggle Switches** - select which source will be live to that channel based on what you have connected to the rear panel input section.
- Input faders** - control individual source levels in the mix.
Note: Never use spray cleaners on the slide controls. Residues cause excessive dirt build-up and this will void your warranty. In normal use slide controls can last for many years. If they malfunction (usually because of a dirty or dusty environment) consult a professional technician.
- Channel Cue Assign** - are used to route Pre Fader Level (PFL) channel audio to the **Headphone Section**. The channel faders do not control the **Cue** volume.
- Effect Send** (Channels 1-4). Depress these buttons when you want the signal from any input channel to be routed to the sampler on the Send Out Jacks.

CROSSFADER

- Crossfader Assign Knob** - determines which input channel will be heard when the crossfader is moved towards the knob. With the crossfader centered, both assigned channels are live. Use the crossfader for fast and seamless segues from one selected channel to the other.
- Replaceable Crossfader** - achieves clean segues between the two input channels selected by the Crossfader Assign.
Note: The crossfader is a user replaceable item and subject to wear. Excessive force can wear out the fader quickly. This is not a warranted item. In case of failure. Simply unscrew the two large screws that hold it in place, lift it out and disconnect its cable. Re-attach the new crossfader and screw the mounting plate back onto the unit - you're back in business!

MICROPHONE

- Neutrik™ "Combo" connector** - allows connection of either a 1/4" jack or an XLR jack. This is ideal for connecting an XLR gooseneck directly into the mixer.

- Treble and Bass Controls** - for fine-tuning the tone of your voice through the sound system. The controls are detented for setting tone "flat".
- DJ Mic Gain Control** - for volume adjustment of the Neutrik™ "Combo" connector on the faceplate.
- Mic 2 Gain Control** - for volume adjustment of the 1/4" input on the rear panel.
- Mic Off/On/Talkover Switch**. **Off/On** turns Mic 1 off and on. Mic 2 is controlled only through the Mic 2 Fader. **Talkover** turns down the input level of your music sources from Channels 1-4. Talkover is very useful for making announcements without adjusting any levels.
Try using this feature for audience participation when you want the music to temporarily cease and the audience to be heard - "YEAH!"

OUTPUTS

- Master Fader** - controls the overall output level.
- Stereo/Mono toggle** - adjusts the **Master** output for stereo or mono operation.
- Booth/Zone Fader** - controls speaker volume for a remote zone or booth monitors. **NOTE: This can also be used to supply line level audio to a lighting controller or to lights that are sound activated.**
- Stereo Auto Peak Hold Level Indicator** - quickly and accurately tracks level of audio output. The red LEDs for +3dB, +5dB and +8dB hold program peaks for a second or two. With peak metering, it's OK to be "in the red" as long as +5dB or +8dB aren't constantly lit. **When using as a master output meter**, set the crossover, equalizer and power amp inputs to avoid distortion at each step in the audio chain. Proper attention to the peak meter results in the punchiest possible sound without audible distortion.

EQUALIZER SECTION

16. **6-Band Stereo Graphic Equalizer (EQ).** EQ compensates for differences in source material sound quality. In ultra-compact mobile systems this EQ can be used to tailor the sound to the acoustical requirements of the room. Center frequencies are 42Hz, 152Hz, 480Hz, 1.5kHz, 4.8kHz and 15.4kHz. Faders have a center detent for an accurate "flat" response. Below is a typical "house" EQ curve. Notice how the knobs above "0" balance out the knobs below. Start with this setting if you've never used a graphic EQ before:

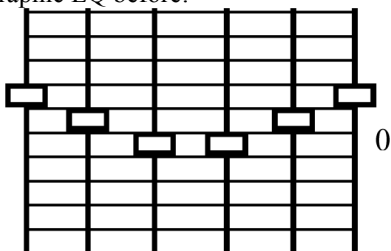

Below is an example of a poor EQ curve because it cuts the output volume down by 6-10dB. You have to compensate by running the **Master** output higher:

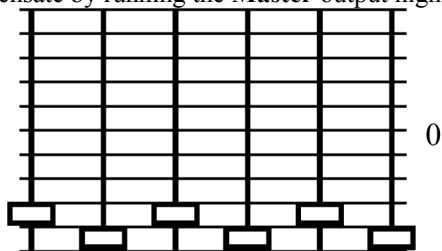

Below is the worst sort of curve to use because you are using EQ to *add volume*. With exaggerated boost you can easily run your power amplifiers into "clipping" (see page 6) and damage your speakers:

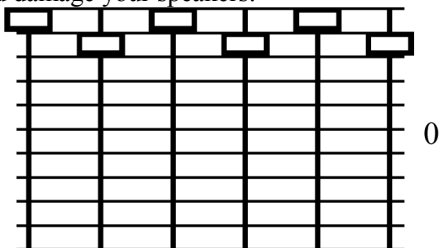
**GENERAL EQ HINTS**

- *Boost the 42Hz band for deep bass tones and solid kick drum sound. Use sparingly because this dramatically increases demand on power amplifiers and could drive them into "clipping".*
- *Cut slightly at 152Hz and more at 460Hz for extra clarity. **Note:** Cutting is preferable to boosting.*
- *Boost 15kHz for a little "sizzle".*
- *As a general rule, less equalization is better!*

17. **Equalizer On/Off.** This controls whether your final output will be routed through the EQ or not.

HEADPHONE CUEING

18. **Headphone Mix** - controls the mix of cue and program (- the final mix of music played through the master output), signals to your headphones. When the knob is moved to the left, all you will hear is the cue source. When the knob is all the way to the right, you will hear what is playing through the master output. By blending, beats can be matched exactly and segues can be smooth when a song is cued.
19. **Headphone Level** – adjusts cue volume.
20. **Headphone Jack** – to plug in your ¼" headphones.
21. **Power Switch** – turns unit on and off.
22. **BNC Connector** – for a 12V gooseneck light to be attached.

SAMPLER OPERATION

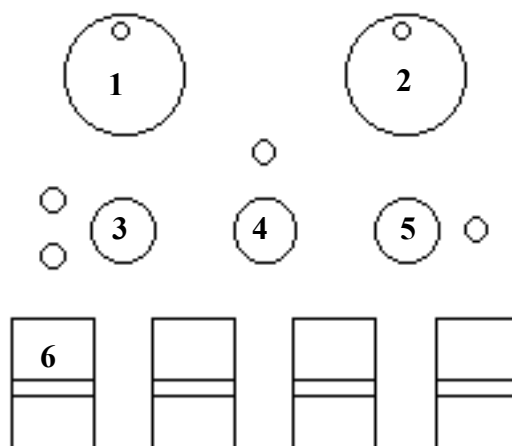

This sampler was designed for ease of use and understanding. It can retain in memory up to 110 seconds worth of sampling. Each bank can save 27.5 seconds for playback even after the unit is shut down. It's as simple as (1) pressing a channel send (2) recording the sample (3) playing it back. Enjoy a whole new way to sample.

1. **Output Gain Control** – adjusts the volume of the sampler.
2. **Pitch Adjust** – changes the playback pitch of the sample. Moving left slows down the playback, moving right speeds it up.
3. **Record/Play mode select** – sets the operation of the sampler.
4. **Stutter** – is used to allow samples to play fully through until retriggering.
5. **Cue** – is used for monitoring the sampler.
6. **Sampler Banks** – for storing 4 samples up to 27.5 seconds in length.

RECORDING SAMPLES

1. Determine your audio source and press the send button of the channel you wish to sample.
2. Set the mode select to record by depressing the button once.
3. Move toggle in either direction to record the sample then move it back to the center to end the sample. The unit will return to play mode. Using the up position allows you to sample without holding the toggle.

PLAYING SAMPLES

1. Move toggle in the down direction to play only once. If the unit is in stutter mode the sample will play to the end unless the toggle is moved again. If the unit is not in stutter mode then playback will end when the toggle is released.
2. Move the toggle upward to play a sample as a loop. Moving multiple samples up will allow them to play in sequence.
3. While a sample is playing as a loop other samples can be played back as well as single play. One single play sample and one loop can be played at the same time creating some very interesting effects.

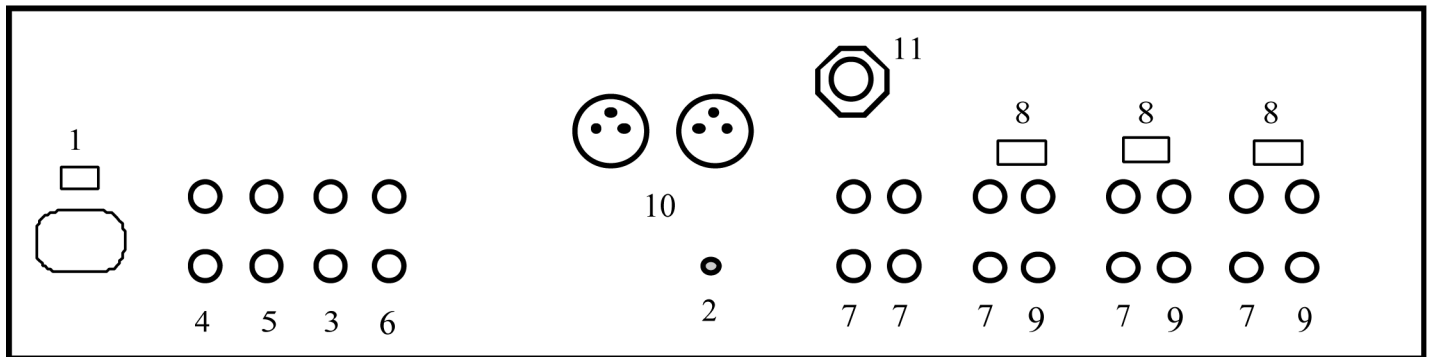
REAR PANEL FEATURES

1. **Power Connector.** Plug in power cord here and check the voltage level to match your country's standard.
2. **GND** is the grounding lug for turntables 1, 2 and 3 (phono inputs on Channels 1, 2 and 3). Always use this connection (your turntable cable should have a grounding wire).
3. The **Stereo Main Outputs** are low-impedance RCA connectors controlled by the **Master** fader.
4. The **Stereo Zone Outputs** are low-impedance unbalanced RCA jacks controlled by the **Zone Level** control.
5. The **Tape Outputs** are low-impedance unbalanced RCA jacks which output the program mix and allow you to connect any recording device.
6. The **Send** can be attached to an external effects processor such as a sampler.
7. **Line Inputs 1-5** are unbalanced RCA jacks. The **Line Input** is selected with the toggle switch on the front panel. You can connect stereo audio from HiFi VCRs, cassette and reel-to-reel tape decks, DAT machines, CD players, laser discs, tuners, even synthesizers or other mixing consoles.
NOTE: Plug mono audio sources into both Left and Right inputs using a "Y" cable connector.
8. **Line/Phono Input switch.** Use this to allow line level equipment to be plugged into your phono inputs giving you a total of 8 line input options.
9. **Phono Inputs on Channels 1, 2 and 3** use unbalanced RCA jacks. Your input signal is fed directly to the **DM1200's** high-quality RIAA phono pre-amplifiers so use this position only for moving magnet cartridges. Line level sources will overload the sensitive phono pre-amps and will sound very bad, so always be sure to toggle the line/phono switch over to line before connection of line sources.
10. The **Balanced Main Outputs** are low-impedance XLR type connectors controlled by the **Master** fader.
11. **Mic 2** is the mic input for Channel 4.

QUICK SETUP DIAGRAM

VERY IMPORTANT: Please read this entire manual before connecting this unit to your system

For optimum performance:

- Always make sure that AC power is OFF while making any connections.
- Use appropriate cables throughout your system. Do not use excessively long cables (i.e. over 50ft/14m) Be sure plugs and jacks are tightly mated. Loose connections can cause hum, noise or intermittence that could easily damage your speakers. Make the input and output connections with readily available low-capacitance stereo cables. Quality cable makes a big difference in audio fidelity and punch. See your Numark dealer or an electronics or audio specialist store if you are not sure which cables to get.
- ALWAYS remember: "TURN AMPS ON LAST AND OFF FIRST". Begin with master faders or volume controls on minimum and the amplifier gain/input control(s) down. Wait 8 to 10 seconds before turning up the volume. This prevents transients, which may cause severe speaker damage.
- Use restraint when operating controls. Try to move them slowly. Rapid adjustments could damage speakers due to amplifier clipping. Avoid amplifier "clipping" at all costs: this occurs when the red LEDs (usually on the front panel of most professional power amplifiers) start flashing. "Clipping" is when the power amplifier is distorting and working beyond it's limits. Amplifier distortion is THE major cause of speaker failure.

Study this setup diagram. Make sure all faders are at "zero" and all devices are off. First, connect all input sources and processors. Next, connect your microphone and monitor headphones. Finally, connect the stereo outputs to the power amplifier(s) and/or audio receivers such as tape decks. Plug your mixer into AC power. Now you are ready to switch everything on.

IMPORTANT: Always switch on your audio input sources such as turntables or CD players first, then your mixer, and finally any amplifiers. When turning off, always reverse this operation by turning off amplifiers, then your mixer, and then input devices.

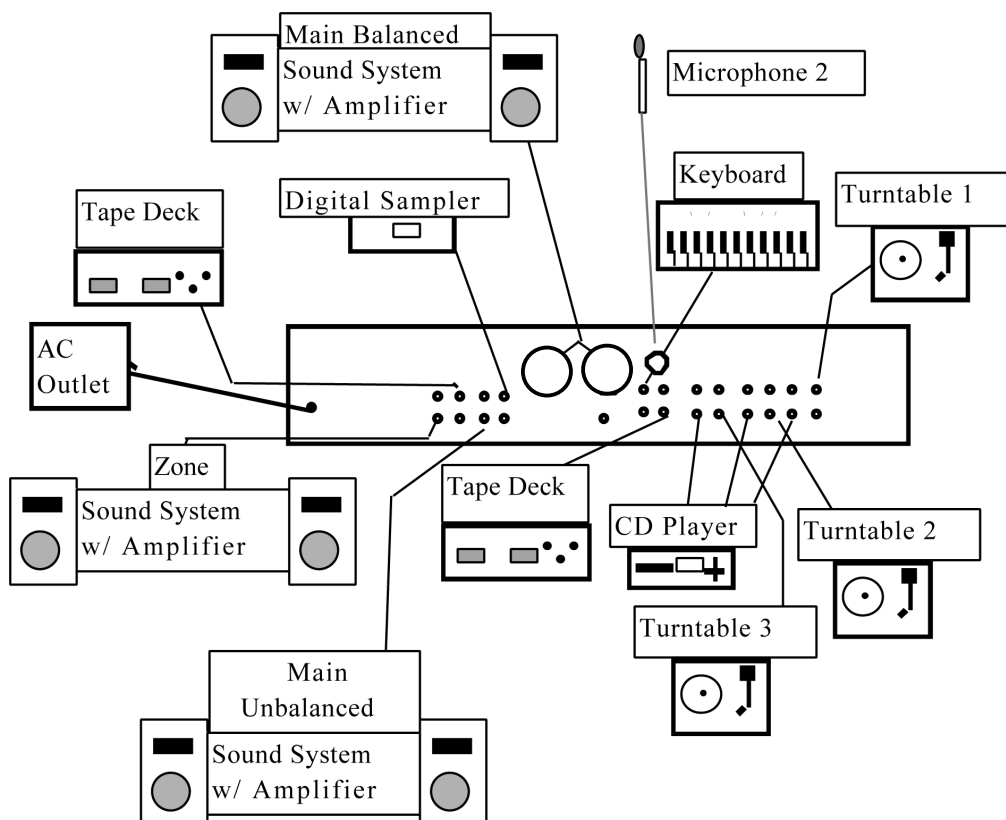

Numark - The Leader in DJ Technology

SPECIFICATIONS

INPUTS:

Line: 10Kohm input impedance
110mV rms sensitivity (for 1.22V output)
Mic: 10Kohm input impedance unbalanced
1.6 mV rms sensitivity (for 1.22V output)
500mV rms max input
Talkover attenuation: variable from no cut to -16 dB
Phono: 47Kohm input impedance
1.8mV rms sensitivity @ 1 KHz (for 1.22V output)

OUTPUTS:

Line: 9V rms max
Headphone Amp: 1V rms watt into 16ohm

Distortion: less than 0.01%

SIGNAL TO NOISE RATIOS* (vs. maximum output):

Line: Better than 96 dB
Mic: Better than 78 dB
Phono: Better than 87 dB

*JIS - weighted

FREQUENCY RESPONSE:

Line: 20 Hz- 22k Hz ± 0.5 dB
Line: 20 Hz- 20k Hz ± 0.5 dB
Phono: ± 1 dB except for controlled attenuation of -3 dB
@ 20 Hz to reduce rumble and feedback

EQUALIZER:

6-Band Stereo Graphic EQ
Band centers 42 Hz, 152 Hz, 480Hz, 1.52KHz, 4.8KHz, 15.36KHz +/- 15 dB

SAMPLER:

Sampling length: 110 Seconds, 27.5 seconds per bank

POWER CONSUMPTION:

20 Watt typical, 28 watt with full headphone output

DIMENSIONS:

482mmx232mmx111mm
19" x9 1/8" x4 3/8"

WEIGHT:

5.1kgs 11.2lbs

BLOCK DIAGRAM

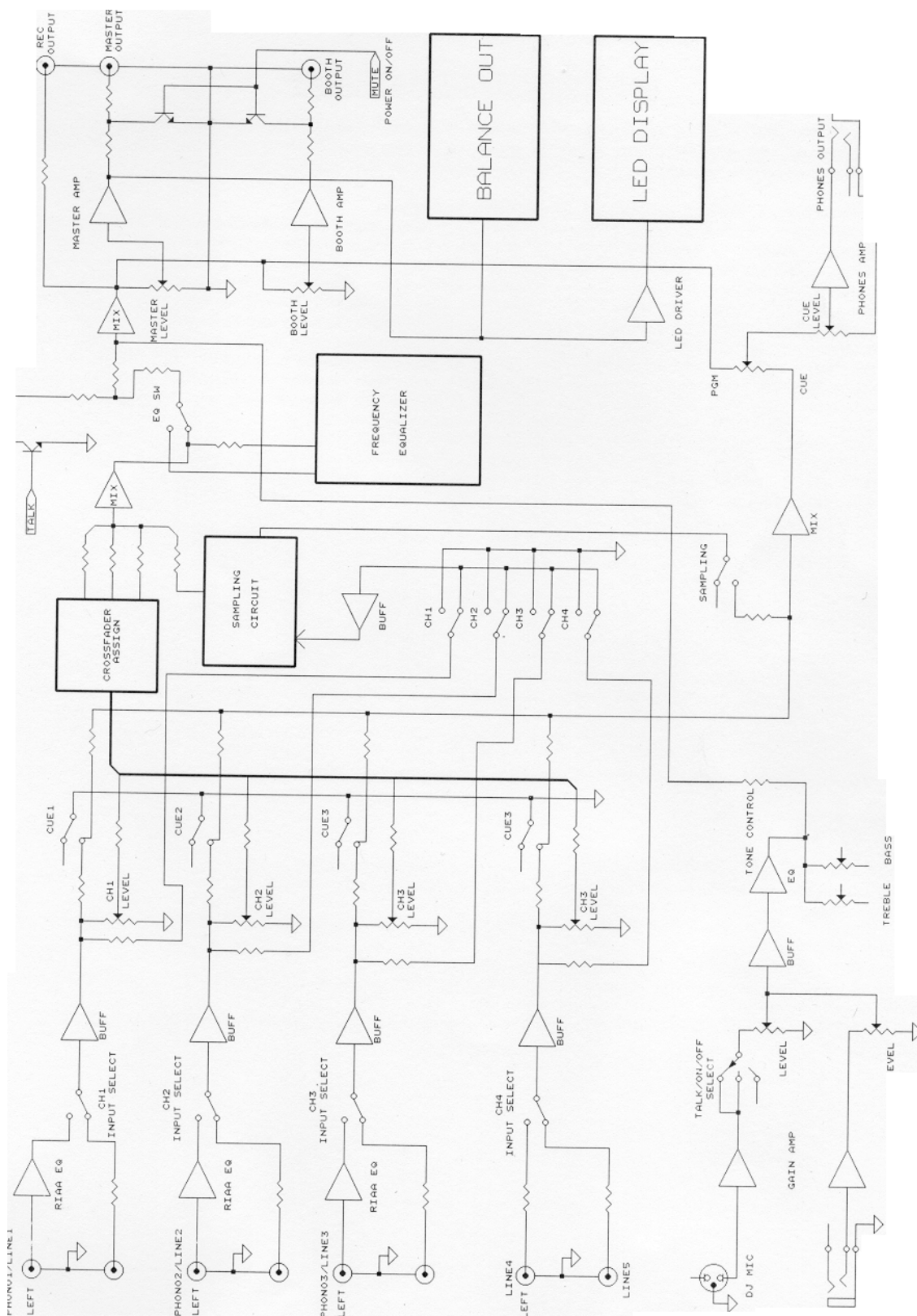

Numark- The Leader in DJ Technology

Numark®

Professional Disc Jockey Products

LIMITED PRODUCT WARRANTY

What is covered and for how long?

1. NUMARK INDUSTRIES LCC ("NUMARK") warrants to the original purchaser that NUMARK products; including but not limited to DJ mixers, amplifiers, CD players, CD Mix Stations, turntables, preamplifiers, beatkeepers, equalizers, microphones, headphones, cartridges, and all other accessories; are to be free from defects in material and workmanship under normal use and service for the period commencing upon the date of purchase from an authorized NUMARK dealer for a period of (1) Year.

What is not covered? This Limited Warranty is conditioned upon proper use of the product by the purchaser.

2. This Limited Warranty does not cover: (a) defects or damage resulting from accident, misuse, abuse, neglect, unusual physical or electrical stress, modification of any part of the product, or cosmetic damage; (b) equipment that has the serial number removed or made illegible; (c) all plastic surfaces and other externally exposed parts that are scratched or damaged due to normal use; (d) defects or damage from improper testing, operation, maintenance, installation, adjustment, or service of the mixers; (e) crossfaders.
3. What are NUMARK'S obligations? During the applicable warranty period, NUMARK will repair or replace, at NUMARK'S sole discretion, without charge to the purchaser, any defective component part of the mixer. To obtain service under this Limited Warranty, purchaser must first contact NUMARK and obtain a return authorization number ("RA#"). Purchaser must then return the mixer to NUMARK in an adequate container for shipping, accompanied by purchaser's sales receipt or comparable proof of sale showing the date of purchase, the serial number of the product, and the seller's name and address. To obtain an RA# and assistance on where to return the mixer, contact NUMARK customer service at 401-295 9000. Upon receipt, NUMARK will repair or replace the defective products. NUMARK may, at NUMARK'S sole discretion, use rebuilt, reconditioned, or new parts or components when repairing any product or replace a product with a rebuilt, reconditioned or new product. Repaired mixers will be warranted for a period equal to the remainder of the original Limited Warranty on the original mixer or for (90) days, whichever is longer. All replaced parts, components, boards and equipment become the property of NUMARK. If NUMARK determines that any mixer is not covered by this Limited Warranty, purchaser must pay all parts, shipping, and labor charges for the repair or return of such mixer.
4. What are the limits on NUMARK'S liabilities? THE WARRANTIES GIVEN IN THIS LIMITED WARRANTY, TOGETHER WITH ANY IMPLIED WARRANTIES COVERING NUMARK MIXERS, INCLUDING WITHOUT LIMITATION ANY WARRANTIES OF MERCHANTABILITY OR FITNESS FOR A PARTICULAR PURPOSE, ARE LIMITED TO THE DURATION OF THIS LIMITED WARRANTY. EXCEPT TO THE EXTENT PROHIBITED BY APPLICABLE LAW, NUMARK SHALL NOT BE LIABLE FOR ANY SPECIAL, INCIDENTAL, CONSEQUENTIAL, INDIRECT OR SIMILAR DAMAGES, LOSS OF PROFITS, DAMAGES TO PURCHASER'S PROPERTY, OR INJURY TO PURCHASER OR OTHERS ARISING OUT OF THE USE, MISUSE OR INABILITY TO USE ANY NUMARK MIXER, BREACH OF WARRANTY, OR NEGLIGENCE, INCLUDING BUT NOT LIMITED TO NUMARK'S OWN NEGLIGENCE, EVEN IF NUMARK OR ITS AGENT HAS BEEN ADVISED OF SUCH DAMAGES, OR FOR ANY CLAIM BROUGHT AGAINST PURCHASER BY ANY OTHER PARTY. THIS LIMITED WARRANTY IS THE COMPLETE WARRANTY FOR NUMARK'S MIXERS, AND IS GIVEN IN LIEU OF ALL OTHER EXPRESS WARRANTIES. THIS LIMITED WARRANTY SHALL NOT EXTEND TO ANYONE OTHER THAN THE ORIGINAL PURCHASER OF THIS PRODUCT AND STATES PURCHASER'S EXCLUSIVE REMEDY. IF ANY PORTION OF THIS LIMITED WARRANTY IS ILLEGAL OR UNENFORCEABLE BY REASON OF ANY LAW, SUCH PARTIAL ILLEGALITY OR UNENFORCEABILITY SHALL NOT AFFECT THE ENFORCEABILITY OF THE REMAINDER OF THIS LIMITED WARRANTY WHICH PURCHASER ACKNOWLEDGES IS AND WILL ALWAYS BE CONSTRUED TO BE LIMITED BY ITS TERMS OR AS LIMITED AS THE LAW PERMITS.
5. This Limited Warranty allocates risk of product failure between purchaser and NUMARK, and NUMARK'S product pricing reflects this allocation of risk and the limitations of liability contained in this Limited Warranty. The agents, employees, distributors, and dealers of NUMARK are not authorized to make modifications to this Limited Warranty, or make additional warranties binding on NUMARK. Accordingly, additional statements such as dealer advertising or presentation, whether oral or written, do not constitute warranties by NUMARK and should not be relied upon.
6. How does state law apply to this warranty? SOME STATES DO NOT ALLOW THE EXCLUSION OR LIMITATIONS OF INCIDENTAL OR CONSEQUENTIAL DAMAGES OR HOW LONG AN IMPLIED WARRANTY LASTS, SO THE ABOVE LIMITATIONS OR EXCLUSIONS MAY NOT APPLY TO PURCHASER.
7. This Limited Warranty gives you specific legal rights. You may also have other rights, which vary from one jurisdiction to another.

RETURN INFORMATION

- a) A Return Authorization number must be obtained from Numark through the address or phone numbers below.
- b) A copy of the original sales receipt must also be included for the equipment to be repaired under warranty.
- c) The faulty equipment must be packed in its original packaging.
- d) One additional outer layer of packaging must be included to ensure product safety. Failure to do so may inadequately protect the equipment in transit and, therefore, jeopardize the customer's warranty.
- e) Numark will not accept COD shipments and no call tags will be issued for merchandise return.
- f) Numark will not return repaired merchandise to customers by priority service, unless by written request at the customer's cost. Requests must be submitted in writing with merchandise returned.
- g) The defective Numark equipment should be sent, FREIGHT PREPAID with Return Authorization number clearly printed on the outer packaging and original sales receipt enclosed to:

Numark INDUSTRIES
Attention: Service Department
11 Helmsman Avenue
North Kingstown, RI 02852 USA

Phone: +1 (401) 295-9000
Fax: +1 (401) 295-5200
Web: www.numark.com